



V
E
R
I
T
A
S

W
H
I
T
E

P
A
P
E
R

Oracle Backup and Recovery Essentials

Information That Every Oracle Database Administrator Should Know

May 2002



Table of Contents

| | |
|---|----|
| Introduction | 1 |
| Oracle Backup Basics | 1 |
| Limitations of Manual Backup Methods | 2 |
| Single-Step Oracle9i Backup and Recovery With NetBackup <i>for Oracle</i> | 3 |
| Requirements for Oracle Backup and Recovery | 4 |
| VERITAS NetBackup <i>for Oracle</i> | 4 |
| VERITAS NetBackup <i>for Oracle</i> Architecture | 5 |
| Improving the Availability of Oracle Databases With NetBackup <i>for Oracle</i> | 5 |
| Hot Backup Support | 5 |
| GUI-Based Oracle RMAN Script Generation Wizard for Easy Backup and Recovery Script Creation | 5 |
| What's New: NetBackup <i>for Oracle</i> and Checkpoint/Restart | 7 |
| Coming Soon: NetBackup <i>for Oracle</i> and Oracle9i RAC (Real Application Clusters) | 7 |
| For the Advanced Oracle DBA: Alternative Oracle Backup and Recovery Methods | 8 |
| Improved Oracle Performance With VERITAS NetBackup <i>for Oracle</i> Advanced BLI Agent | 8 |
| How It Works: NetBackup <i>for Oracle</i> Advanced BLI Agent | 8 |
| A Brief Introduction to Storage Checkpoints | 9 |
| Hardware Snapshot Technologies: NetBackup and Storage Arrays | 10 |
| How NetBackup Array Integration Option Works | 10 |
| Server-Free Oracle Backup | 11 |
| Storage Area Networks | 12 |
| VERITAS NetBackup Database Archiver: The Future of Oracle Backup and Recovery | 12 |
| The Problem: Long-Term Data Storage | 12 |
| The Solution: VERITAS NetBackup Database Archiver | 12 |
| How NetBackup Database Archiver Works | 13 |
| Conclusion: VERITAS Offers the Leading Solutions for the Protection of Your Oracle Data | 15 |

Introduction

Oracle database backup and recovery is an inherently challenging process that becomes more difficult as databases grow in size and as increasing demands on database availability limit the time available to perform backups. Many organizations use custom-made scripts and manual backup methods to protect their Oracle data. However, these methods do not have the reliability required by enterprise environments, and do little to improve the ongoing availability of critical systems. These organizations are not suited to handle today's rapidly growing data environment.

Eliminating backup overhead on production Oracle databases is also a requirement for many of today's online, all-the-time critical business applications. Oracle is the foundation for most business applications, so even the slightest impact or downtime to an Oracle database can result in significant business losses. A backup and recovery solution must provide both efficiency and speed to support these environments.

VERITAS NetBackup™ is an enterprisewide backup and recovery solution. VERITAS Software has worked closely with Oracle Corporation to develop a highly scalable and reliable online backup and recovery solution for Oracle databases. VERITAS NetBackup™ *for Oracle* protects both data and the availability of Oracle applications.

This paper will discuss the fundamentals and essentials that every Oracle database administrator (DBA) should know and follow when creating their Oracle backup, restore and recovery strategy. Alternative Oracle backup methods such as block-level incremental backup, split-mirror backup and server-free backup will also be discussed. The Oracle RMAN backup and recovery strategy discussed will be useful to all Oracle DBAs, whether they are responsible for managing a small 1 GB or a large multiterabyte or petabyte database. This paper will also talk about the future direction of Oracle database backup and recovery.

Oracle Backup Basics

If you run critical applications with Oracle databases, then you probably already invest in an Oracle backup and recovery solution. For many organizations, a solution is an assortment of scripts and manual processes managed and maintained by in-house DBAs. For various reasons, many organizations use backup schemes that no longer efficiently back up their data. Often, a problem is not discovered until a recovery fails, resulting in a costly database outage or loss of data.

A backup solution that once worked well for smaller databases does not address the needs of a larger Oracle database, or a large database with increasing availability requirements. Symptoms of an inadequate backup/recovery solution include:

- Excessive DBA time spent maintaining and managing backups, without scheduled automated backups
- Infrequent backups, leading to lengthier recoveries
- Prolonged outages due to data restoration errors or problems finding the right files
- Operator support required for changing tapes

In the enterprise environment, Oracle databases offer unique and specific challenges for backup and recovery. These include:

- **Managing large amounts of data** — Database backups tend to be very high-volume operations — managing these backups may mean managing tens, hundreds or even thousands of gigabytes of secondary storage.
- **Maintaining high availability** — As databases grow in size, the time spent creating a backup may exceed a designated "backup window."
- **Handling complex recovery scenarios** — Recovering an Oracle database is much more than simply restoring a file from tape. It requires identifying the cause of the failure, identifying and restoring the correct set of files and tablespaces, restoring the right archived redo logs, and recovering the database appropriately for the current situation.

It is not enough to have Oracle database experts in-house — you also need storage management capabilities for handling and managing high-volume backups for optimal performance and manageability. VERITAS NetBackup combines enterprise-level storage management capabilities with Oracle-specific database functionality to provide a highly scalable backup and recovery solution for protecting the user's Oracle database data.

Limitations of Manual Backup Methods

Oracle provides a rich variety of backup and recovery options. These are described in greater detail in the Oracle Administration Guide and in a number of third-party books on Oracle database administration. This paper presents the most basic description of these processes to highlight the inherent challenges of manual methods.

Oracle backups can be divided into two categories:

- **Cold backups** are taken when the database is shut down, creating a consistent backup image (the database is in a consistent state).
- **Hot backups** are taken while the database is online. These may be either full or incremental backups. For very large databases, for example, it may be necessary to back up one tablespace one day, another the next, etc. In addition, hot backups are not inherently consistent; they must be managed in conjunction with archived redo logs and online redo logs to bring the database to a consistent state. There is also the situation where restores may be performed in parallel with backups (e.g., a user drops a tablespace, so it must be recovered while a database backup is in progress). Performing hot backups requires putting the Oracle database into a special backup mode, generating some additional redo and rollback information during the backup.

These two methods can be used in combination, with full cold backups once a week and tablespace-level hot backups on a daily basis. In addition, Oracle is continuously adding information to redo logs, which contain the transaction-by-transaction history of the database and are used to bring the database to a consistent state during a restore/recovery. The database backup process must manage all the files comprising the database, including data files, control files, parameter files and archived redo logs.

Recovering from a failure is a more complex operation, whose exact steps depend on the kind of failure experienced. Basically, there are two phases to database recovery:

1. **Data restoration** — Identifying and restoring the appropriate data files, archived redo logs, control files and parameter files from secondary media to their appropriate location on primary disk.
2. **Database recovery** — Taking the appropriate steps in Oracle to recover the database, either to a specific point in time or to the most recent point before the failure, if recovering from a database failure.

Determining which files to restore is challenging, particularly if you have been performing hot backups over a long period of time without performing a cold backup. A point-in-time recovery requires different steps than an up-to-the-minute recovery. Restoring the wrong files (for example, restoring the control file when it is not necessary to do so) will cause more problems than the original outage. Determining which archive logs are required also delays recovery.

Many Oracle environments rely on the DBA to create and run backup scripts to manage their regularly scheduled Oracle backups. These scripts can perform either cold or hot backups, and will automate backups to some degree. However, using user-created scripts is still primarily a manual approach to Oracle backups because:

- Maintaining the scripts is a manual, ongoing process. For example, as new tablespaces and data files are added to the database, the scripts must be updated.
- The scripts typically lack the robust error management and reusability of commercial software, and as such require ongoing maintenance.

- Although scripts automate backups, recovery is a manual process, requiring the presence and guidance of an experienced DBA.
- Operators still need to be available to change tapes manually during backups.

Manual methods are adequate for some installations. For example, if the database is small, and if an adequate backup window is available, then a DBA has the luxury of simply shutting down the database and performing a consistent “cold” backup. Likewise, if the database does not undergo significant daily changes, then backups do not need to occur as often.

However, as databases grow in size, manual methods become more difficult to manage. A large database may have hundreds of data files; tracking and storing the backup files on secondary media requires time-consuming organization. Very large backups may need tape changes during the backup, making automation even more necessary.

Most important, manual backups still leave organizations vulnerable to errors and delays in the recovery process. Organizations must examine carefully if their backup and recovery solutions protect not only their data but also the availability of their critical systems.

Single-Step Oracle9i Backup and Recovery With NetBackup for Oracle

The following real-life example illustrates the steps required to restore an entire Oracle9i database that has been lost due to application failure, the most common failure in the database environment. On the left is the simple procedure necessary when using Oracle Recovery Manager in conjunction with VERITAS NetBackup for Oracle. On the right are the steps necessary when using native Oracle9i utilities and operating system procedures.

| Restore With NetBackup and RMAN ¹ | Restore Without RMAN ² |
|--|---|
| 1. Startup mount | 1. Determine which datafiles need to be recovered |
| 2. Restore database | 2. Use backup records and utilities (e.g., bplist) to figure out which backups to restore |
| 3. Recover database ³ | 3. Shut down the database |
| 4. Alter database open | 4. Restore the datafiles |
| | 5. Determine which archived redo logs are required to recover the tablespaces |
| | 6. Restore the archived redo logs |
| | 7. Startup mount |
| | 8. Recover the database using the archived redo logs |
| | 9. Alter database open |

Table 1: Comparison of the two methods available to recover Oracle9i databases

¹ Assuming that a control file for this database exists

² Assuming that a NetBackup standard policy was used to back up the files

³ After the initial Oracle RMAN configuration has been established, then all subsequent restores and recoveries using NetBackup for Oracle require only one step.

Requirements for Oracle Backup and Recovery

A good Oracle backup and recovery solution must meet the following requirements:

- **High availability of current systems** — If you have a small backup window, or no backup window at all, you need a high-performance solution that supports hot backups and minimizes the impact of backups on the production Oracle database.
- **Reliable results** — Oracle recovery can be complex; the backup solution must be reliable and must provide the functionality to recover from a wide variety of Oracle database failures.
- **Manageability** — A good backup and recovery solution should completely automate the backup processes, so unattended backups can take place at any time. It should allow the DBA to schedule and prioritize backups, so the most critical Oracle data is backed up first in case something goes wrong during the backup and not all of the data is backed up successfully. And the solution must provide end-to-end backup management, from tracking and restoring the right files to expiring old backups.
- **Flexibility** — An Oracle backup and recovery solution should give you the capability of recovering a single tablespace, performing online recoveries where possible, or recovering to a point in time. To enable this, the backup solution must be closely integrated with the Oracle database.

Delivering all of these capabilities in an enterprise environment, with critical data at stake, requires a solution that encompasses both database-specific functionality and enterprise-class storage management capabilities.

VERITAS NetBackup *for Oracle*

VERITAS NetBackup is an enterprise backup and recovery solution that provides highly scalable support for a variety of servers and clients, together with extensive media management capabilities. NetBackup supports all leading tape vaults and optical disk libraries, and is excellent at managing distributed backups, securely and safely, for optimal performance.

As an Oracle backup solutions partner, VERITAS has created database-specific support for Oracle databases using Oracle-supplied interfaces. NetBackup *for Oracle* is tightly integrated with Oracle's Recovery Manager (RMAN), which is a key component of the Oracle 8.x and Oracle9i databases. These interfaces, created and supported by Oracle Corp., manage basic backup and recovery operations, automating much of the work that previously the DBA would need to perform manually.

The NetBackup server manages backup policies and schedules and communicates with the storage media. A single NetBackup server can manage multiple Oracle database backups, providing centralized storage management and leveraging high-speed and high-capacity storage devices. This solution combines both storage management and Oracle expertise to improve the availability, manageability and reliability of Oracle data and servers.

VERITAS NetBackup for Oracle Architecture

The NetBackup for Oracle architecture and how it works is shown in Figure 1 below:

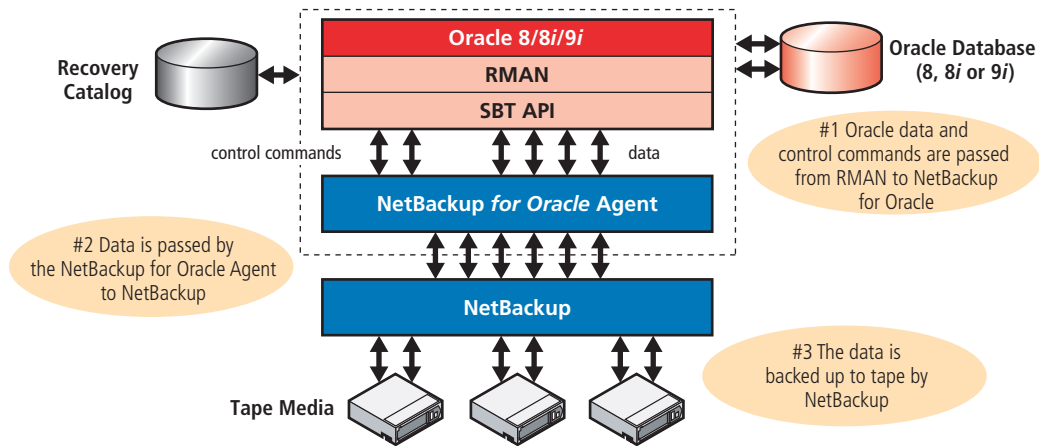

Figure 1: Architecture for RMAN-based Oracle backup

Improving the Availability of Oracle Databases With NetBackup for Oracle

VERITAS NetBackup for Oracle is a flexible and scalable solution for enterprise database backups. Whether for a small, critical database or a number of large databases, NetBackup gives DBAs the necessary tools to protect both the data itself and the availability of the Oracle database.

NetBackup optimizes database availability in two important ways. Superior backup performance and hot backup support minimizes the impact of backups on production Oracle systems. Fast data restoration and simplified recovery brings databases back online faster after failures.

Hot Backup Support

VERITAS NetBackup for Oracle supports both cold and hot backups, so DBAs can create backup schedules that best suit their needs and adjust those schedules as their databases grow.

Through its integration with Oracle RMAN, NetBackup for Oracle simplifies making and maintaining hot backups. It manages the processes of altering the database state for backups, backing up all of the appropriate files and archived redo logs, and tracking all of the backup information needed for a fast and reliable recovery.

GUI-Based Oracle RMAN Script Generation Wizard for Easy Backup and Recovery Script Creation

VERITAS has developed a GUI-based Oracle RMAN Script Generation Wizard that makes it easy and fast to create Oracle backup and recovery scripts. The wizard allows the user to specify the appropriate information needed to create backup scripts, including the selection of data that will be backed up, the type of backup performed, the backup schedule that will be used and the setting of the RMAN I/O values and backup-set limits. The wizard assists the user in creating recovery scripts that streamline the recovery process, reducing database downtime. This results in a reduction in the time needed to create RMAN scripts, while also providing essentially error-free execution. Training costs are also minimized as the Script Generation Wizard makes it easy to create RMAN scripts in a few easy steps.

Below are some examples of the NetBackup for Oracle RMAN Script Generation Wizard developed by VERITAS Software:

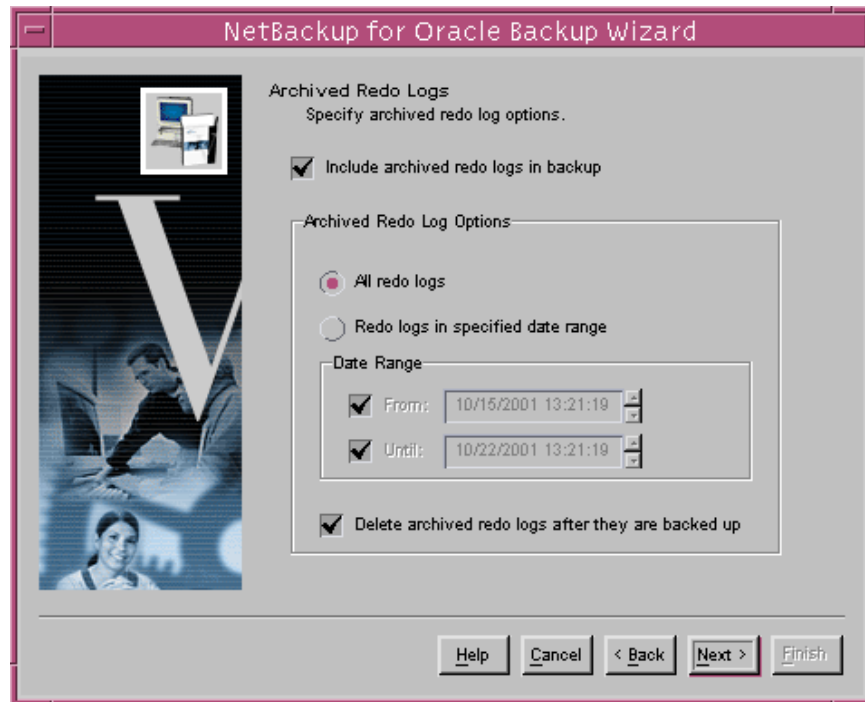

Figure 2: The Oracle Backup Wizard Archived Redo Logs screen provides greater control over how the archived redo logs are processed during and after a backup.

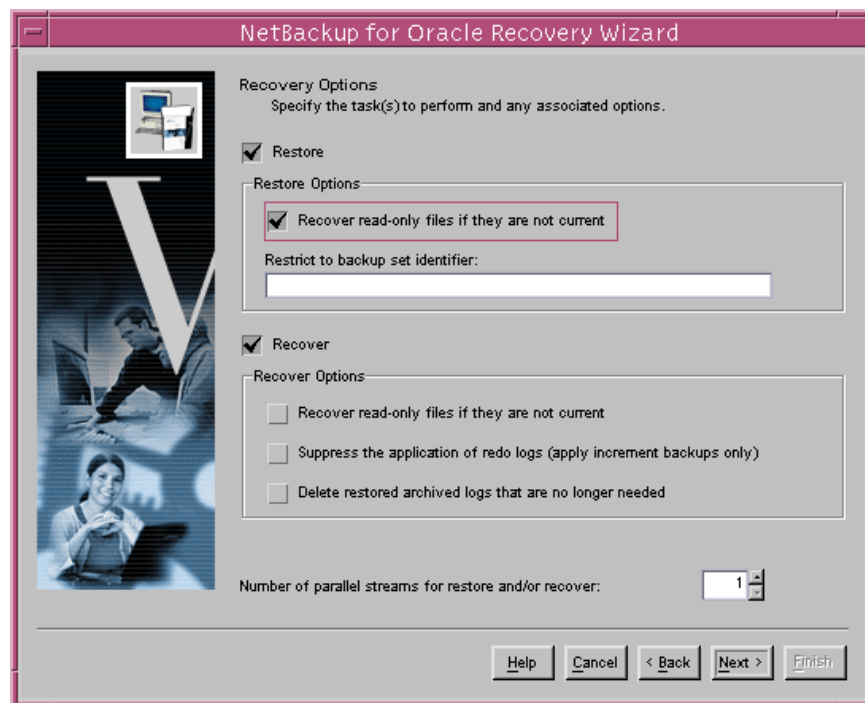

Figure 3: The Oracle Recovery Wizard Recovery Options screen provides a variety of choices for restore and recovery.

The VERITAS NetBackup *for Oracle* RMAN Script Generation Wizard is available with the following VERITAS products:

- VERITAS NetBackup *for Oracle* Agent
- VERITAS NetBackup *for Oracle* Advanced BLI Agent
- VERITAS NetBackup ServerFree Agent *for Oracle*

What's New: NetBackup *for Oracle* and Checkpoint/Restart

NetBackup *for Oracle* now supports the backup and recovery checkpoint/restart functionality that comes with Oracle9i (called Resumeable Backup & Restore by Oracle Corp.). This allows users of NetBackup *for Oracle* to resume a backup that has failed, from the point where the initial backup failed. For example, if a backup fails after it has completed backing up 80 percent of the Oracle9i datafiles, the user is now able to resume the backup from the last successfully backed up datafile where the backup failed. The user would now have to back up only the remaining 20 percent of the data that was not backed up during the first attempted backup. Before NetBackup *for Oracle* and checkpoint/restart, the user would not be able to restart the backup from the point where the backup failed, having instead to restart the Oracle backup from the beginning to complete a successful backup. The benefit of this new feature is that NetBackup *for Oracle* backups can be completed more efficiently and in a shorter period of time in the event of backup failure. This is very important as database backup windows are rapidly decreasing as databases grow larger. Therefore, this new technology allows for corporate IT resources to be used more efficiently.

Coming Soon: NetBackup *for Oracle* and Oracle9i RAC (Real Application Clusters)

In joint testing at Oracle's Redwood Shores, CA, headquarters, the NetBackup *for Oracle* Agent was installed on two Oracle9i servers in a RAC configuration. Backups were started on both Oracle9i servers with NetBackup. One of the Oracle9i servers was intentionally disabled, causing the backup to fail on that server. However, the backup that was started on the other Oracle9i server continued processing uninterrupted and completed successfully. This is one demonstration that NetBackup *for Oracle* is able to protect Oracle9i databases in a RAC environment.

Figure 4 below illustrates the above:

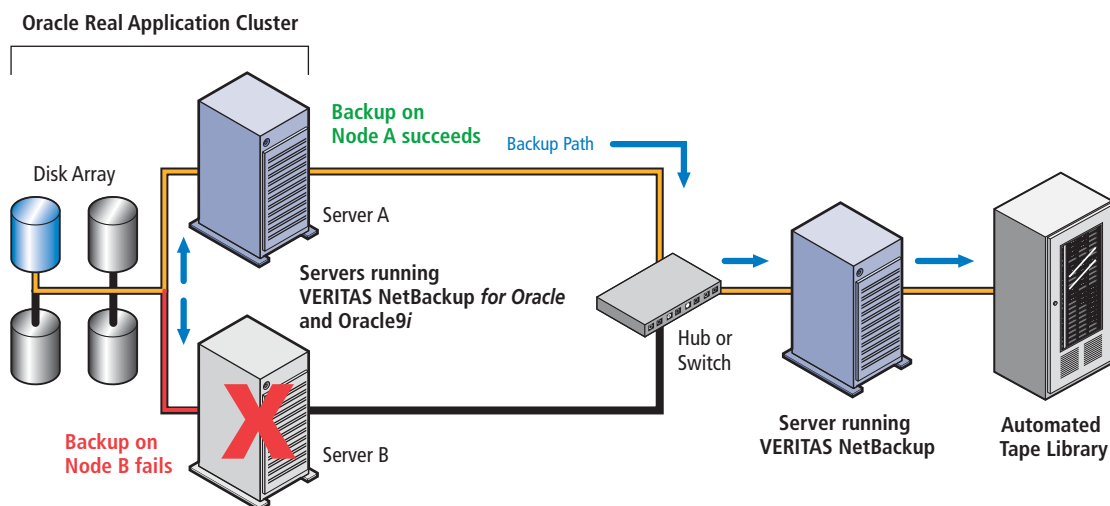

Figure 4: NetBackup *for Oracle* backing up Oracle9i in a RAC environment

For the Advanced Oracle DBA: Alternative Oracle Backup Recovery Methods

Improved Oracle Performance With VERITAS NetBackup *for Oracle* Advanced BLI Agent

The VERITAS NetBackup *for Oracle* Advanced BLI Agent provides zero downtime, nondisruptive snapshot-based backups. Unlike expensive hardware-based split-mirror solutions, NetBackup *for Oracle* Advanced BLI Agent drastically decreases the time needed for Oracle backup and recovery by greatly reducing the amount of data involved in the backup process. Fully integrated with the Oracle Recovery Manager (RMAN) interface, the Advanced BLI Agent addresses the growing need for high-performance data protection, and augments the increased manageability and simplified recovery that RMAN makes possible.

How It Works: NetBackup *for Oracle* Advanced BLI Agent

(requires VERITAS Database Edition™ *for Oracle*)

Here are the steps required for a backup using NetBackup *for Oracle* Advanced BLI Agent.

1. **Create the Snapshot/Frozen Image** — First, the file system needs to be quiesced and taken offline for just seconds. At this time a file system Storage Checkpoint is created using VERITAS Database Edition *for Oracle*. A blockmap is created, which keeps track of the changed file system blocks.
2. **Block-Level Incremental Backup** — The changed data blocks are then backed up from the Storage Checkpoint, which is a snapshot image of the database and the underlying file system at any point in time. The overhead is taken off of the live file system since the backup is accessing the data blocks from the Storage Checkpoint. Using RMAN Proxy Copy, the data is read and written to tape by the NetBackup media server, taking the overhead off of the Oracle database server.

The NetBackup *for Oracle* Advanced BLI Agent uses Oracle's RMAN Proxy Copy to perform backups. Proxy Copy allows NetBackup *for Oracle* Advanced BLI Agent, instead of Oracle, to back up the changed file system blocks for the files specified by the user. This gives NetBackup control over the data transfer from the Oracle datafiles on disk to the storage devices that write the data to tape. The result is that NetBackup, not Oracle RMAN, decides how and when to move the data. This procedure transfers most of the overhead of the backup onto the NetBackup media server, taking most of the I/O workload off of the Oracle production database server. It also reduces CPU utilization on the production Oracle database during backups. The result is a quicker and more efficient backup.

A Brief Introduction to Storage Checkpoints

The VERITAS NetBackup *for Oracle* Advanced BLI agent uses VERITAS Storage Checkpoint™ technology, which is a feature of the VERITAS Database Edition *for Oracle*. A Storage Checkpoint is a snapshot image of the database and the underlying file system at a specific point in time. VERITAS Storage Checkpoints are disk- and I/O-efficient, providing a point-in-time view of the file system using the copy-on-write method. These snapshots of the file system are persistent and available after reboot. Storage Checkpoints can be mounted read-only or read-write as if they are a regular file system.

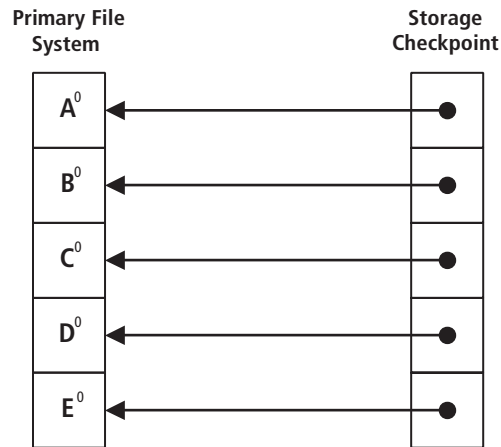

Figure 5: Simplified illustration of the initialization of a Storage Checkpoint

In Figure 5 above, the Storage Checkpoint is pointing at the primary file system. No data blocks have been written to the Storage Checkpoint.

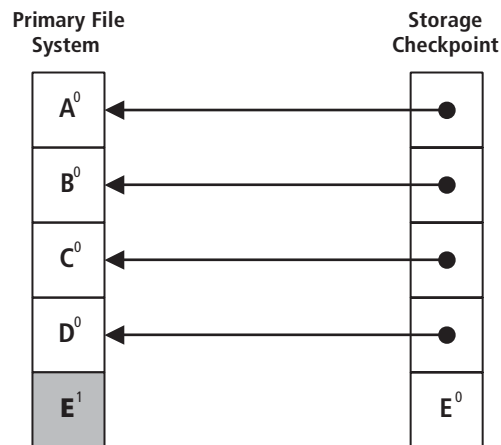

Figure 6: Updates to primary file system

In Figure 6 above, block E⁰ has been changed. As E¹ is written to the primary file system, block E⁰ is written to the Storage Checkpoint.

Storage Checkpoints can be used for a wide range of application solutions, including online backup/recovery, investigation into data integrity and performing decision-support queries.

Hardware Snapshot Technologies: NetBackup Array Integration Option

Advanced backup and recovery techniques, such as the use of hardware split mirrors, have become a reality for IT environments with large disk arrays. IT users can effectively offload much of the backup impact from the primary Oracle database server by using frozen images or point-in-time copies of data as the basis for backup. The NetBackup Array Integration Option provides hardware-based snapshot technology to efficiently back up data stored on storage arrays.

Hardware snapshots, often known as third mirrors, are physical copies of data that usually reside on disk arrays or subsystems. These data sets are volume-level copies of data. To back up this data, the mirror is split and can be backed up without affecting production systems. After the backup is complete, the mirror is resynchronized and is once again a complete data set. Although this process creates a physical copy of data, it requires disk space and needs to restore an entire volume rather than an individual file.

How the NetBackup Array Integration Option Works:

The split-mirror backup performs the following tasks as shown in Figure 7 below:

- Step 1** — VERITAS NetBackup Array Integration Option splits the third mirror created in the disk array so the data is ready to be backed up.
- Step 2** — The data traffic is sent to the NetBackup server and backed up to the attached tape library.
- Step 3** — When the backup is completed, NetBackup re-establishes the synchronization between the third mirror and the original mirror.

The result is a backup with minimal impact on the production Oracle database server.

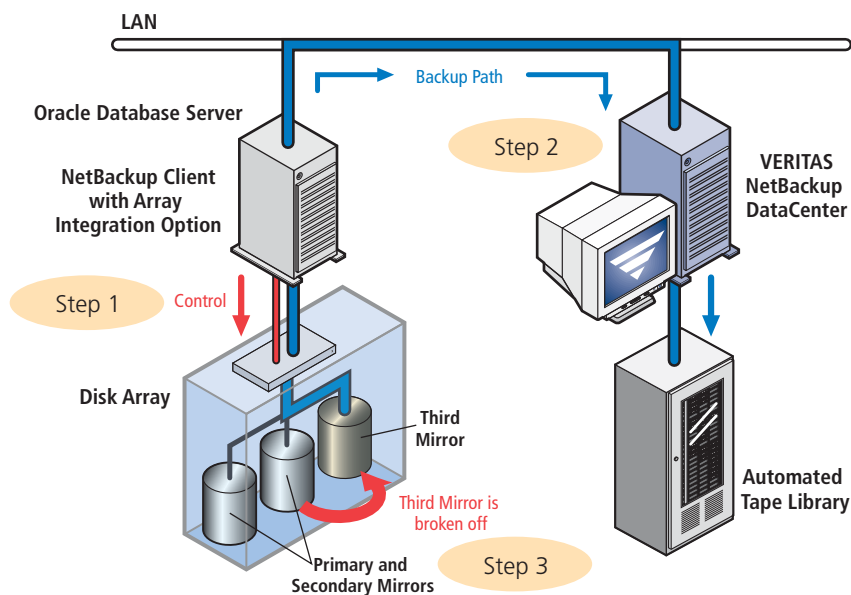

Figure 7: Split-mirror backup and NetBackup Array Integration Option

The NetBackup Array Integration Option backs up and recovers Oracle databases, and delivers integration with EMC TimeFinder, HP Surestore Business Copy XP and Hitachi Data Systems ShadowImage. It is supported on Sun Solaris and HP-UX.

The VERITAS NetBackup Array Integration Option supports the NetBackup ServerFree Agent, allowing for server-free Oracle backups. The Array Integration Option also supports VERITAS Volume Manager™ and VERITAS File System™.

Server-Free Oracle Backup

NetBackup ServerFree Agent *for Oracle* provides server-free backup for Oracle databases using snapshot, mapping and third-party copy data movement technologies. This technology removes the backup workload from the Oracle database server. Since the overhead is taken off of the Oracle production database during the backup, performance is significantly improved for users who access the database during backup.

NetBackup ServerFree Agent *for Oracle* Consists of Three Steps:

Step 1. Data Snapshot — VERITAS NetBackup must create a point-in-time snapshot of the data to perform backups efficiently without an application or database server. The first step in the frozen image or snapshot creation process is to pause the application or database briefly by placing Oracle into backup mode. This process flushes all buffers and makes sure the data is constant at a known point in time. Once this point has been established, a snapshot backup can be engaged using hooks into the VERITAS Volume Manager or File System snapshot technologies. Multiple snapshot methods give users an unparalleled level of flexibility.

Step 2. Logical Disk Object Mapping — The underlying technology layer between a snapshot and server-free data movement is logical disk object mapping. VERITAS has developed this technology because it is crucial that the data is reliably mapped so its physical location is known. After the snapshot has been taken, the ServerFree Agent maps the data by drilling down through the I/O stack and linking the logical file names to the actual physical blocks of data. In the event of a file system reorganization, sector slippage or RAID 5 degraded performance, the data can be remapped to make sure its integrity is preserved. This technology layer is essential for server-free data movement. Without it, the potential of data corruption is significant when data needs to be restored to the server. Once the mapping (block list) is completed, it can be sent to the third-party copy engine.

Step 3. True Server-Free Data Movement — When the snapshot and mapping operations are completed, the data is ready to be moved by the SCSI Extended Copy Command⁴ that can reside in either a storage area network (SAN) hardware device or even on a NetBackup media server. In either architecture, the data is no longer moved by the application or database server, but rather offloaded to a third party, either a SAN hardware device or the NetBackup media server. The SCSI Extended Copy engine handles the actual movement of backup data directly from disk to tape in a SAN.

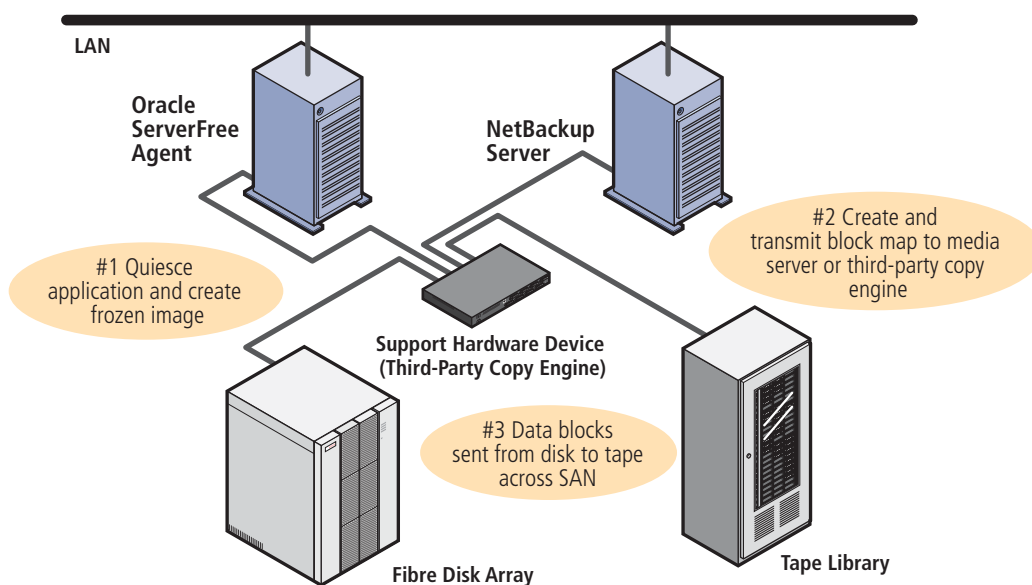

⁴ The SCSI Copy Command is a block-oriented command that provides device-to-device data movement.

Storage Area Networks

With VERITAS NetBackup Shared Storage Option™, you can share storage devices (such as high-speed, high-capacity tape changers) dynamically in a heterogeneous Oracle database server environment. For example, you can allocate two drives in a robotic device for a specific Oracle database backup; NetBackup dynamically releases those drives once the backup is completed. This feature works in a SAN or a SCSI switched environment. This capability lets organizations use their storage hardware more effectively and efficiently with their Oracle database servers. Here is an example of Oracle databases running in a SAN environment:

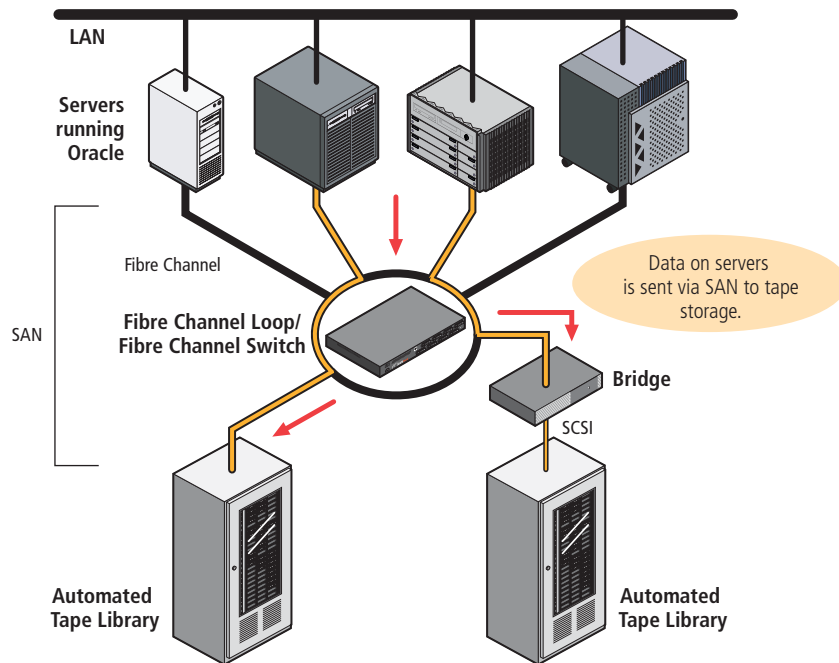

Figure 8: An example of Oracle backup in a heterogeneous SAN environment

VERITAS NetBackup Database Archiver: The Future of Oracle Backup and Recovery

The importance of preserving database data for long periods of time and then retrieving this data within hours or minutes is more critical than ever before. VERITAS NetBackup Database Archiver Agent enables you to extract and archive a subset of mission-critical database data from an Oracle database. The Database Archiver then enables you to quickly restore and import this data into the same or another Oracle database at any time in the future when the data needs to be retrieved, without being dependent on the environment's original configuration, Oracle database version, machine operating system version or associated applications.

The Problem: Long-Term Data Storage

Many U.S. companies today are required by law to keep their corporate data for long periods of time. For example, the possibility of an audit requires corporations and individuals to keep their records for seven years or longer. Some financial institutions are required to keep their data for 100 years. Although these are extreme cases, there is a need to preserve data for longer periods of time.

The Solution: VERITAS NetBackup Database Archiver

As backup windows become nonexistent, and the volume of data that needs to be backed up increases dramatically, the ability to use your corporate IT resources efficiently becomes more critical. VERITAS NetBackup Database Archiver Agent lets

the user back up critical Oracle data quickly and easily. The Database Archiver gives the user the flexibility to create backup schedules that will back up specific Oracle tables, columns or rows, instead of having to back up the entire Oracle tablespace or database. The added flexibility to recover only certain Oracle data in the event of data loss significantly reduces the time and effort required to recover critical Oracle data.

VERITAS NetBackup Database Archiver Agent reduces the amount of data kept online in the Oracle database. After the Oracle tables, columns, and/or rows are archived, a database administrator can more effectively tune the database and provide better application performance. In addition, decreasing the amount of data that is regularly backed up reduces the backup window required to complete routine backups. The data that has been archived and deleted from the online database can be quickly restored if necessary.

VERITAS NetBackup Database Archiver Agent uses state-of-the-art technology to provide this added functionality to NetBackup users. The Database Archiver exports selected data from Oracle database tables by first converting the data into XML format, and then backing up the resulting XML files to tape. The XML format is a system, application and database-independent format. The XML format is also self-identifying, so it contains the information for understanding the format of the data, as well as the data itself.

This archived data can be preserved indefinitely until it is necessary to recover it. The Database Archiver is best suited for the long-term archival of data when the probability of needing the data in the short-term is low. The key value is database, operating system and application independence. When a user requests this data, the archived data is then imported from tape and inserted back into any properly structured database table.

How NetBackup Database Archiver Works:

Hypothetical Case Study: Company XYZ

Company XYZ is a financial institution that must keep long-term records due to U.S. law. It is now April 2002.

The Database Archiving Process

Company XYZ's current storage environment consists of the following:

- One NetBackup master/media server running VERITAS NetBackup DataCenter™ 4.5
- One NetBackup DataCenter 4.5 client
- One Sun E6500 running Solaris 8
- One Oracle 8.1.6 database
- One NetBackup Database Archiver Agent⁵
- One STK tape library for tape storage

A typical method that Company XYZ uses to archive their Oracle data is as follows:

Company XYZ uses NetBackup DataCenter to create a policy to archive its Oracle data. Once the NetBackup policy is initiated, the Database Archiver automatically executes data-extraction scripts. Exporting the queried Oracle data at the specified level of granularity (e.g., table, column, row) in several Oracle data streams, the data is passed to the NetBackup Database Archiver Agent. The query results are then converted into XML format and sent to the NetBackup master/media server, which in turn writes the data to tape.

⁵ The NetBackup Database Archiver requires NetBackup DataCenter 4.5.

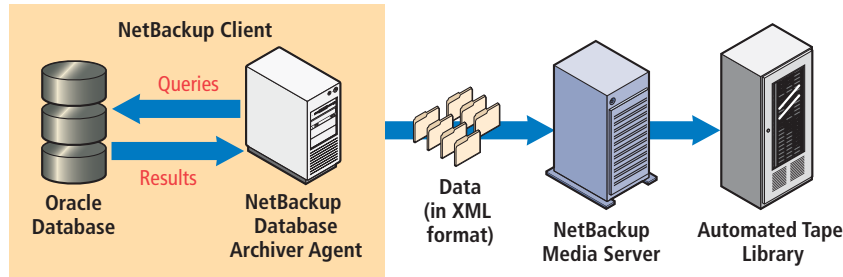

Figure 9: NetBackup Database Archiver export process

The Emergency: The Audit

It is now May 2003. Company XYZ is being audited and has to recover data from April 2002.

The Recovery Process Using the Database Archiver

Company XYZ's environment is much different than it was in April 2002.

Company XYZ's current May 2003 storage environment includes a new Sun Fire E15000 server running Solaris 9, which has replaced its old Sun E6500 that was running Solaris 8. Company XYZ also has upgraded its database from Oracle 8.1.6 to Oracle 9.0.1.

Company XYZ does not have the time to re-create its original April 2002 environment. However, with NetBackup Database Archiver, Company XYZ can retrieve its data quickly within its current environment.

Company XYZ will use NetBackup DataCenter to start a restoration of the data. The data is retrieved from the tape that has the April 2002 data, and the NetBackup master/media server passes the data to the NetBackup Database Archiver Agent residing on the machine where the Oracle9i instance is running. The Database Archiver would convert the XML-formatted data into SQL-compliant insert statements that import the data into the Oracle9i database instance. The April 2002 data is now available to the Oracle user.

Now that the data has been recovered, the user can retrieve the data from the Oracle database and create reports with the data as needed. The result is that Company XYZ is able to use the Database Archiver to quickly retrieve its data without going through a complicated hardware and software redeployment.

As an alternative to importing the data back into the Oracle database, the XML-formatted data and metadata can be restored directly to an operating system directory where it can be viewed and manipulated using standard XML and operating system tools. This allows even greater flexibility for quickly retrieving the necessary information without importing it back into an existing Oracle database.

The Result: The DBA's Life is Made Easier

The NetBackup Database Archiver simplifies the lives of database administrators. Oracle DBAs will find value in a product that allows critical data to be retrieved in hours instead of days. Managers will find value in this product because important data will always be readily available. Managers will not have to allocate budgets for personnel and hardware to either re-create or maintain old and outdated software and hardware configurations.

Conclusion: VERITAS Offers the Leading Solutions for the Protection of Your Oracle Data

VERITAS is committed to providing quality Oracle database backup and recovery solutions to meet the needs of your enterprise, whether your company is a startup with a small Oracle database or a large Fortune 100 corporation with multiple Oracle databases and many terabytes or petabytes of data. Below is a list of VERITAS NetBackup software solutions available to protect your mission-critical Oracle databases:

- NetBackup *for Oracle* Agent
- NetBackup *for Oracle* Advanced BLI Agent
- NetBackup Array Integration Option (for Oracle databases)
- NetBackup ServerFree Agent *for Oracle*
- NetBackup Shared Storage Option for use with Oracle databases
- NetBackup Database Archiver

VERITAS Software is committed to delivering quality solutions for your Oracle databases, now and in the future.



V
E
R
I
T
A
S

W
H
I
T
E

P
A
P
E
R

VERITAS Software Corporation
Corporate Headquarters
350 Ellis Street
Mountain View, CA 94043
650-527-8000 or 866-837-4827

For additional information about VERITAS Software, its products, or the location of an office near you, please call our corporate headquarters or visit our Web site at www.veritas.com.

sales@veritas.com

Copyright © 2002 VERITAS Software Corporation. All Rights Reserved. VERITAS, VERITAS Software, the VERITAS logo, and all other VERITAS product names and slogans are trademarks or registered trademarks of VERITAS Software Corporation in the US and/or other countries. Other product names and/or slogans mentioned herein may be trademarks or registered trademarks of their respective companies. Specifications and product offerings subject to change without notice. May 2002.

02-20444